



Geologic Disposal Options in the USA

**Ernest Hardin, Francis D. Hansen and Andrew Orrell
Sandia National Laboratories
Albuquerque, New Mexico**

**Nuclear Waste Technical Review Board Winter Meeting
Las Vegas, NV
February 15-16, 2011**

SAND2011-0867C

Introduction

- **The USA has many geologic settings suitable for deep geologic disposal of nuclear waste**
- **There is substantial confidence that compliance with regulatory standards can be demonstrated**
- **Rock types include salt, shale, and granite (and other massive, competent rock types)**
- **Media-specific, internationally recognized disposal concepts**

Siting and Geologic Considerations

- **Depth** – The disposal horizon is determined by site-specific conditions
- **Unit Thickness** – Maximal thickness is desired to ensure radionuclide migration does not exceed regulatory criteria or boundaries
- **Uniformity and Structure** – The potential repository interval and surrounding rock should be reasonably homogeneous both vertically and horizontally
- **Seismicity** – Seismically quiescent regions favor repository design, operations, and long term performance

Desirable Attributes of the Geologic Setting

- **Hydrogeology – Low hydraulic conductivity**
 - Approx. 10^{-12} m/sec or less
- **Self-Sealing, Plastic Deformation Characteristics**
 - Reestablish diffusion-dominated transport conditions
- **Hydrogeochemistry – Reducing Chemical Conditions**
 - Limit corrosion of engineered barriers & waste forms
 - Reduce solubility for most radionuclides
 - Improve sorption

Granite Outcrops in the United States



- Includes a range of competent, crystalline rock types
- The USA had an R&D and siting program for crystalline rock, until the 1980s
- Fractured/unfractured
- Saturated/unsaturated
- International progress (e.g., Swedish KBS-3)

Shale Provinces in the United States

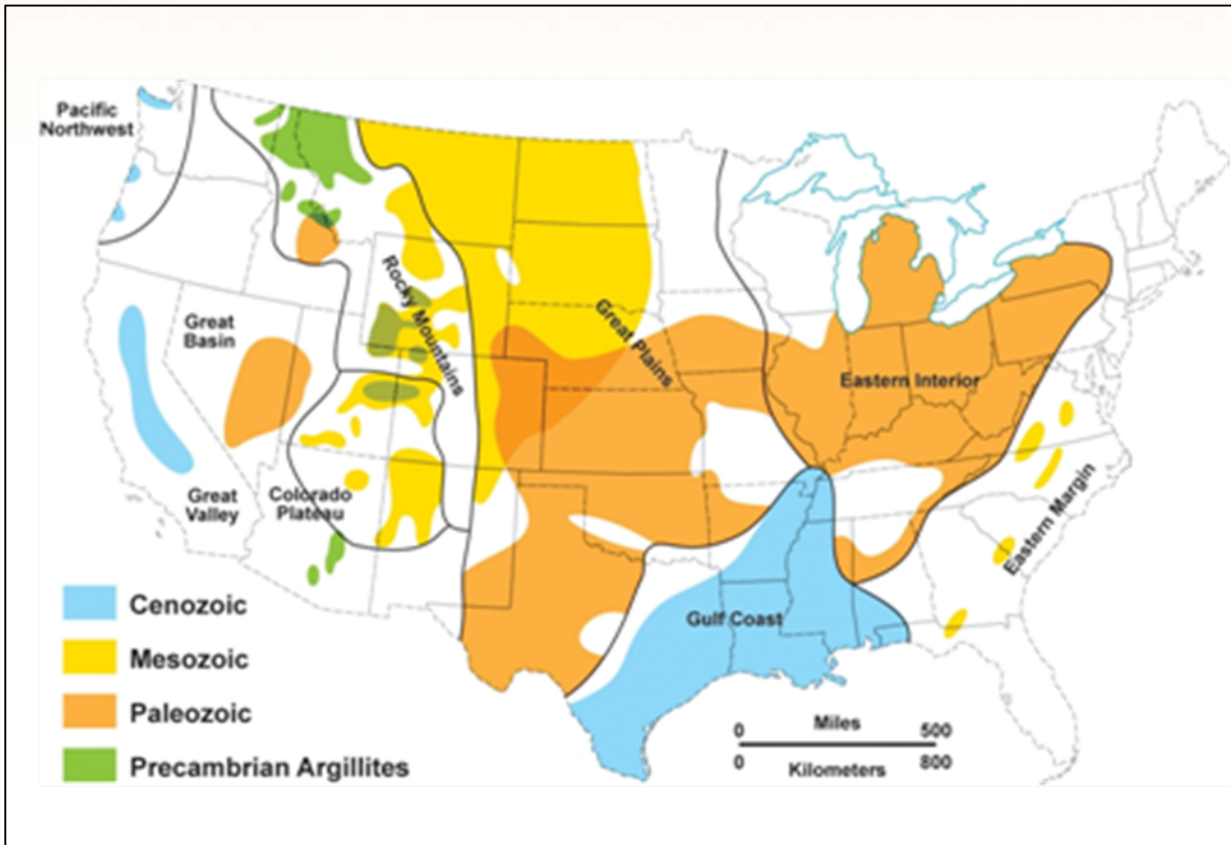

- Includes a range of plastic to indurated clay-rich lithologies
- The USA had active shale repository programs in the 1970s and 1980s
 - Thermomechanical laboratory and field tests
- International progress (e.g., French program at Bure locality)

Salt Deposits in the United States

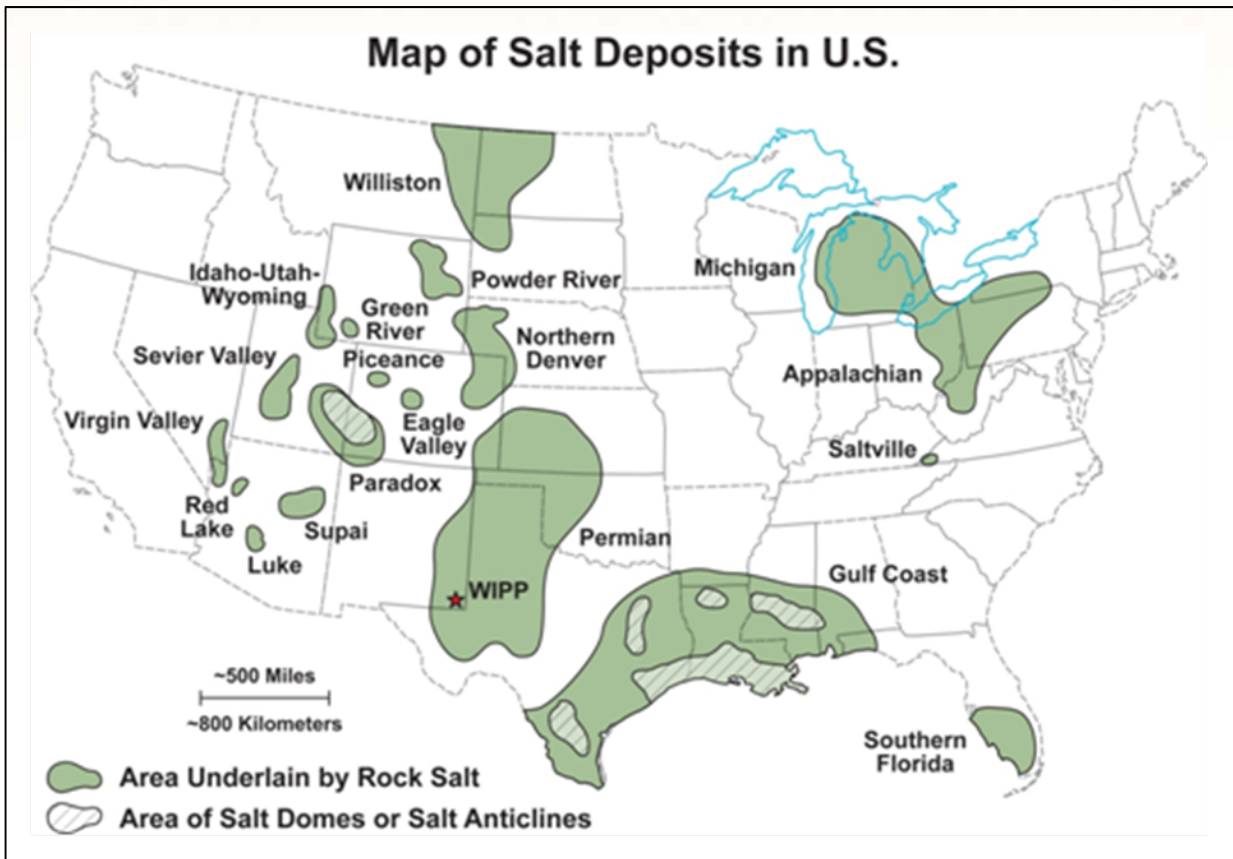

- The USA has supported significant salt repository investigations
 - Project Salt Vault
 - Avery Island
 - WIPP (limited thermal testing)
- International interest is high (e.g., Germany)

Depth to Basement Rock in the United States

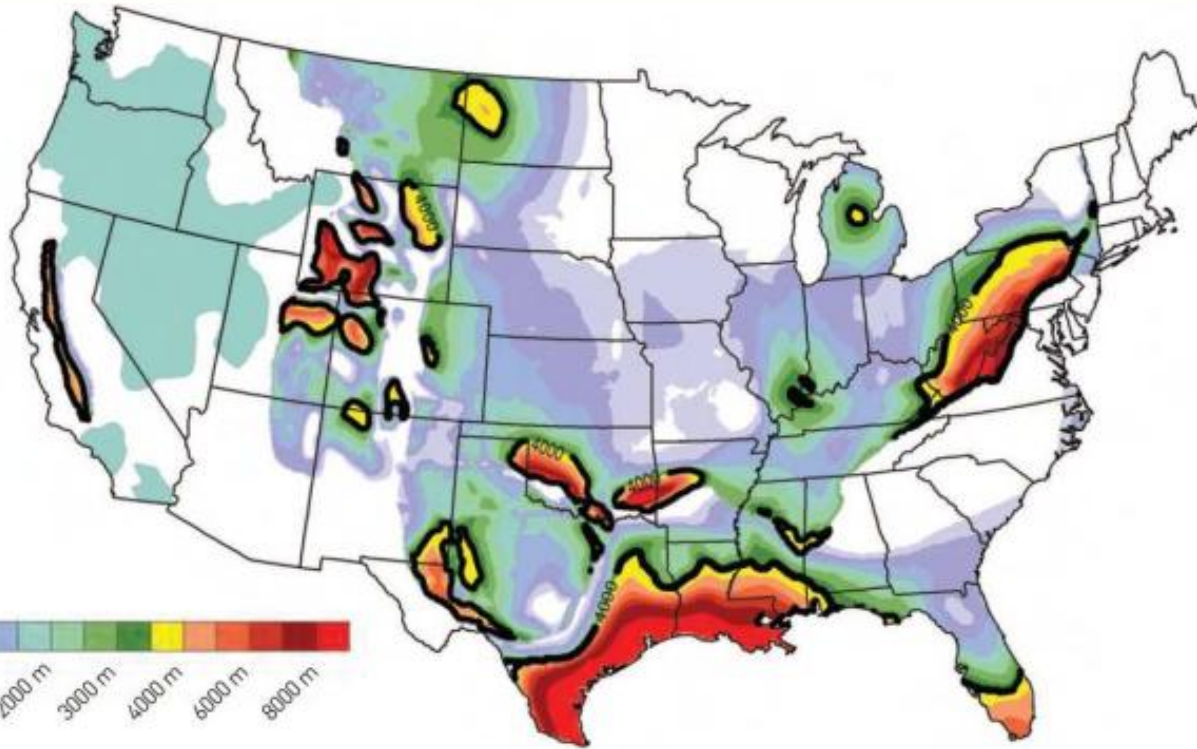

- Very deep holes (3 to 5 km)
- Crystalline basement rock
- Less research than mined repositories

Repository Disposal Concepts

- **A repository disposal concept requires:**
Waste Stream + Geologic Setting + Concept of Operations
- **Concepts for geologic disposal have been developed in several countries**
- **The following slides give a general overview**
 - Granite/crystalline rock
 - Clay/shale
 - Salt repository
 - Deep borehole disposal concept

Representative Disposal Concept for Mined Granite Repository

- **Sweden, Finland, Spain, Switzerland**
- **Spent fuel or HLW**
- **Reducing, undersea, crystalline host rock**
- **Vertical & horizontal emplacement modes**
- **Well studied concept:**
 - Cast iron insert
 - Copper or steel canister
 - Compacted clay buffer
 - Drift backfill
 - Plugs and seals

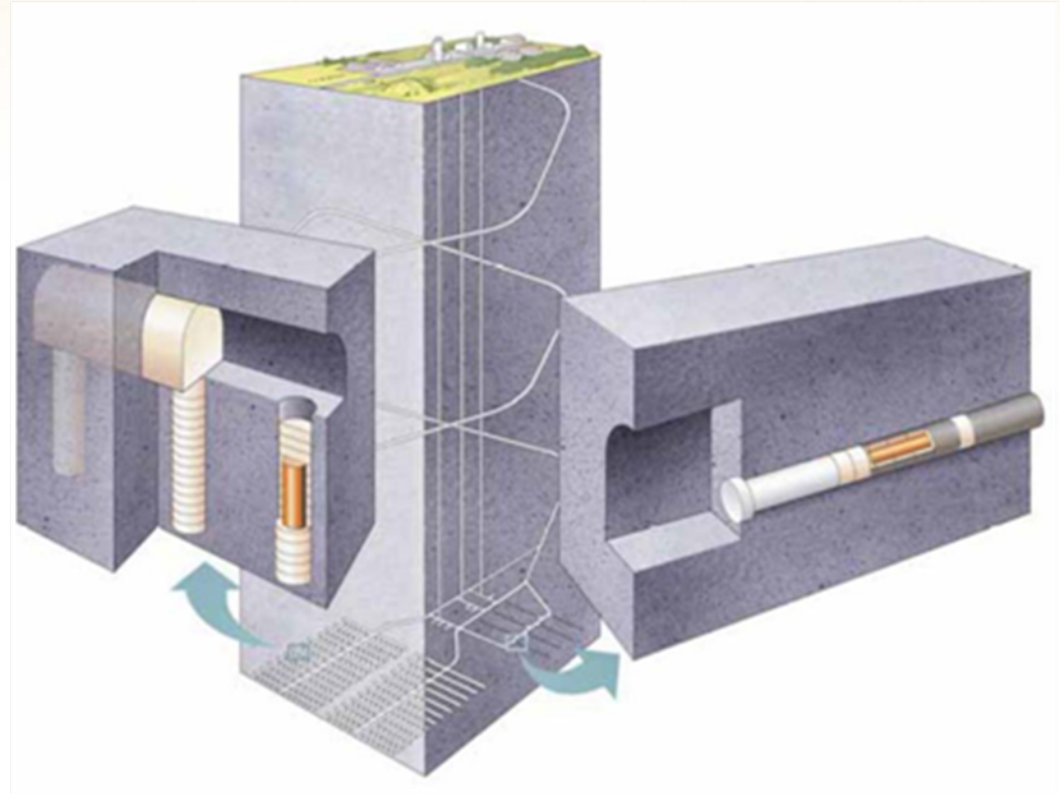

Clay/Shale Disposal Concepts

- Borehole & in-drift emplacement modes
- Reducing host rock
- Steel canister
- Plugs and seals

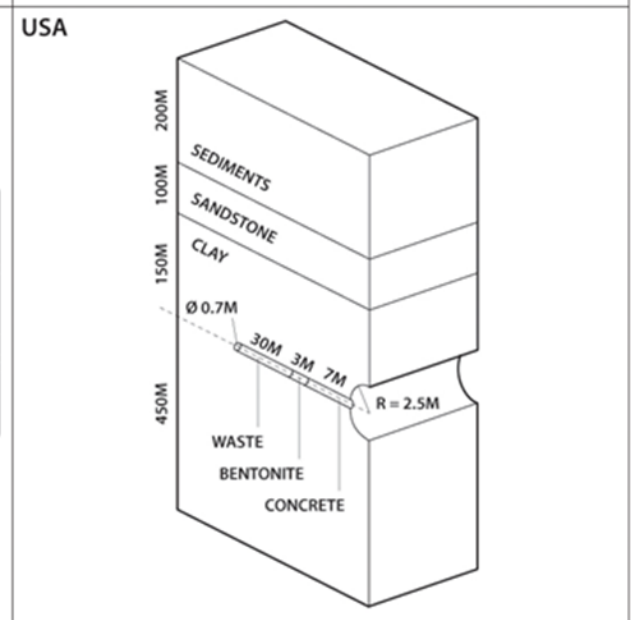
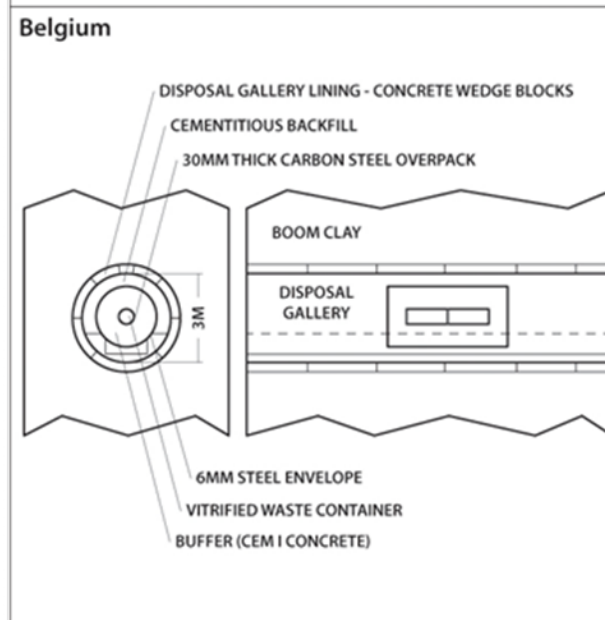
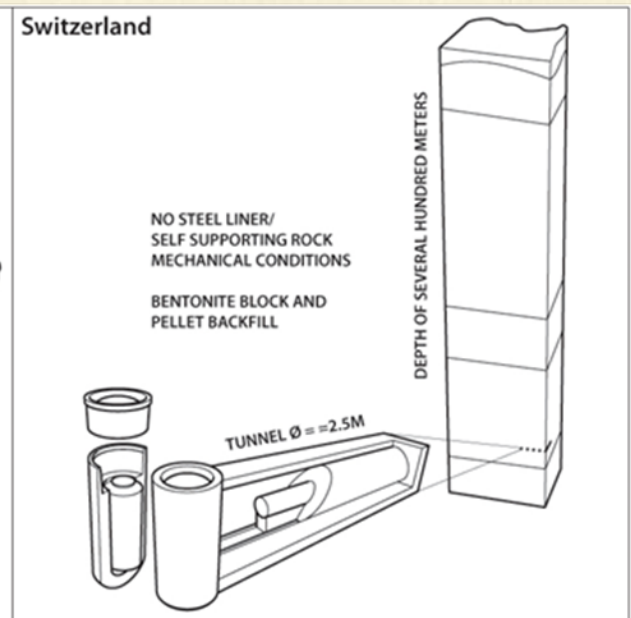
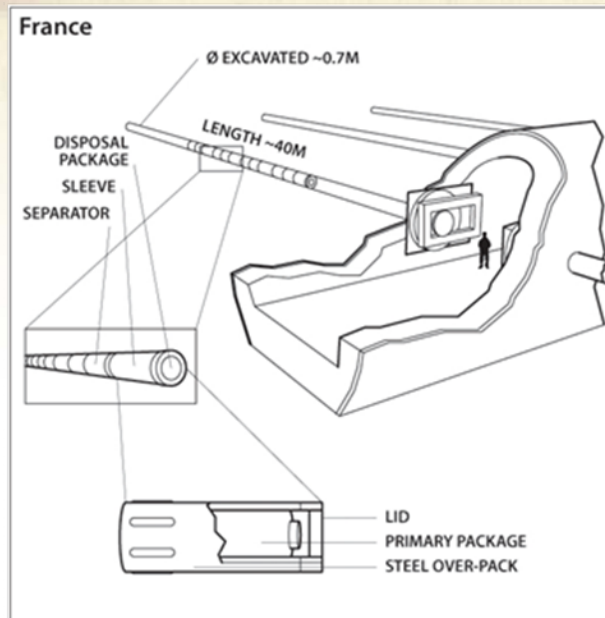

Salt Repository Disposal Concept

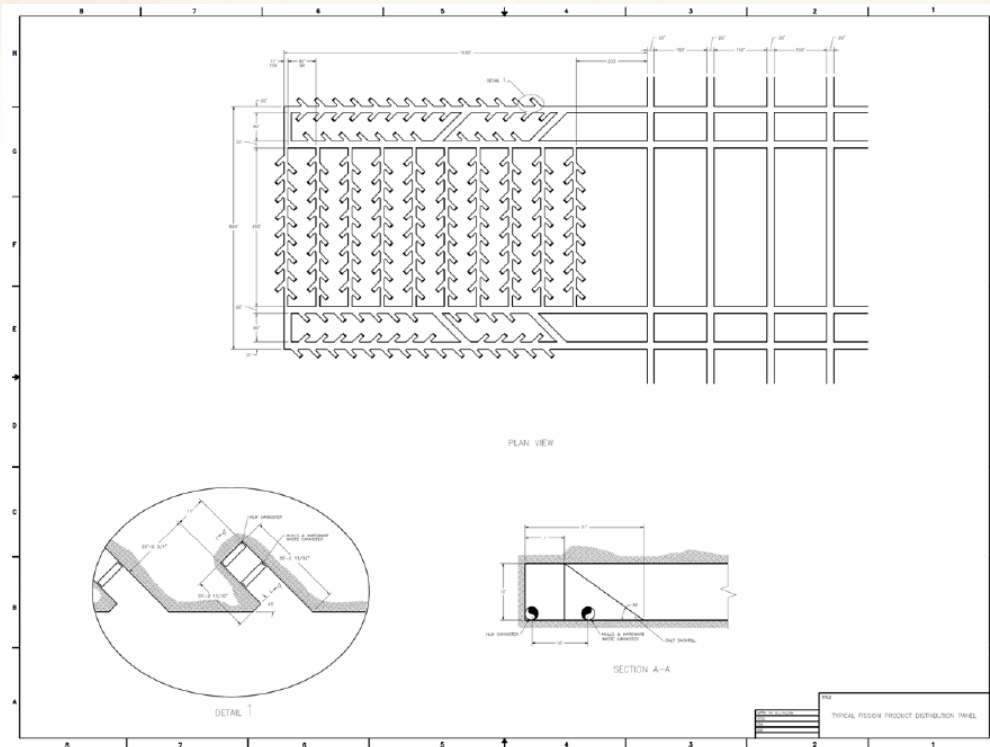

(Washington Savannah River Co. et al. 2008)

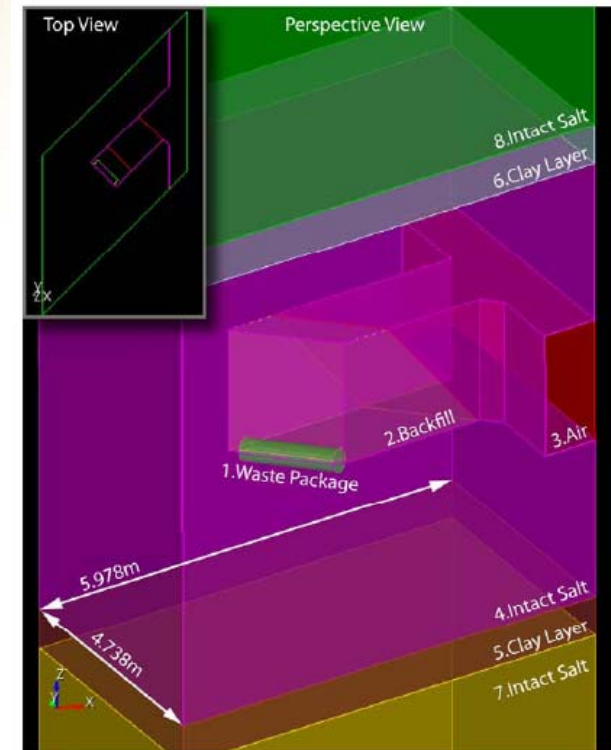

(Clayton & Gable 2009, AFCI-WAST-PMO-MI-DV-2009-000002)

- Based on WIPP experience
- Cover waste canisters with crushed salt (subject to heating, re-consolidation)

Deep Borehole Disposal Concept

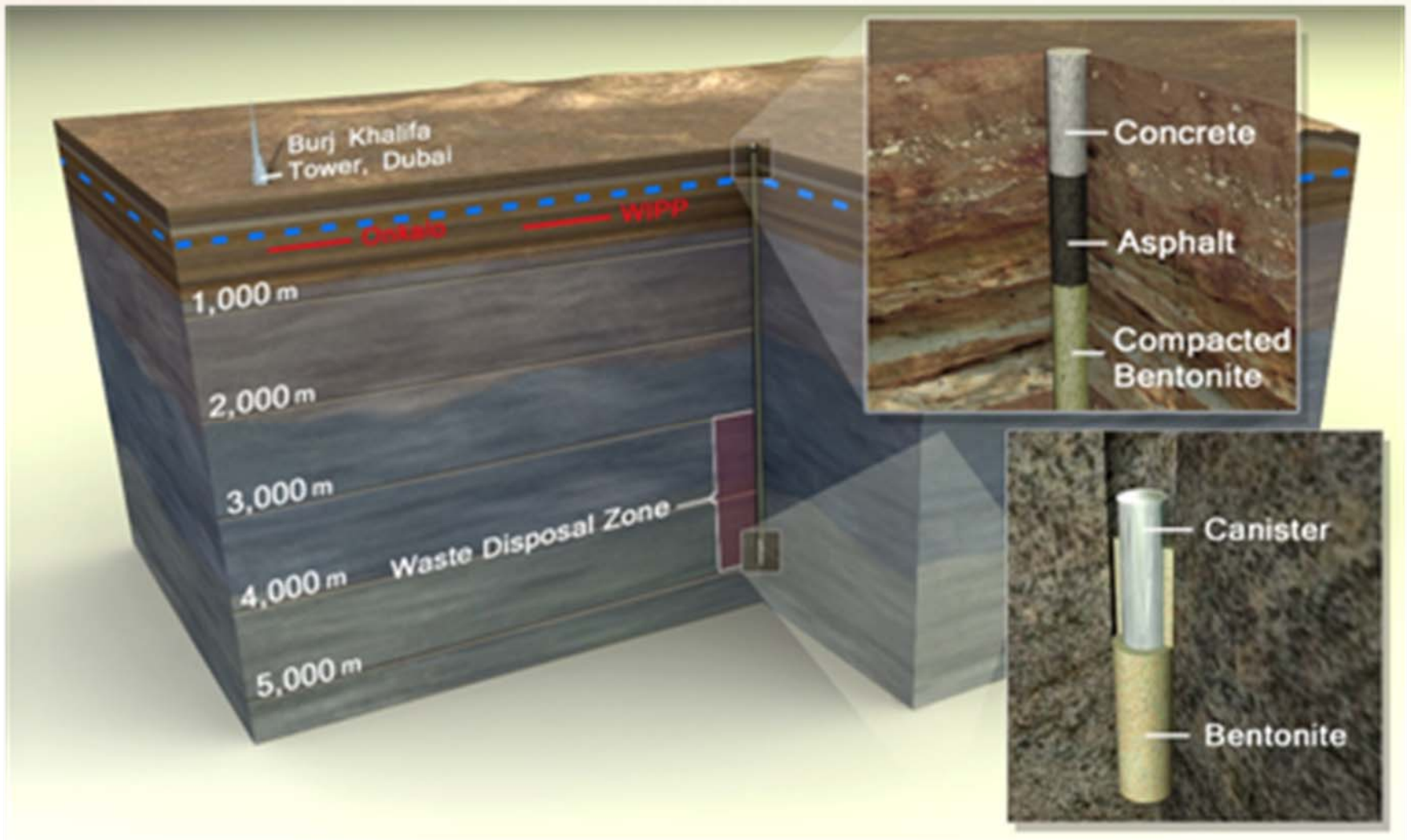

Comparison of Disposal Concepts

Property	Salt	Shale	Granite	Deep boreholes
Thermal conductivity	High	Low	Medium	Medium
Permeability	Practically impermeable	Very low to low	Very low (unfractured) to permeable (fractured)	Very low
Strength	Medium	Low to medium	High	High
Deformation behavior	Visco-plastic (creep)	Plastic to brittle	Brittle	Brittle
Stability of cavities	Self-supporting on decade scale	Artificial reinforcement required	High (unfractured) to low (highly fractured)	Medium at great depth
In situ stress	Isotropic	Anisotropic	Anisotropic	Anisotropic
Dissolution behavior	High	Very low	Very low	Very low
Sorption behavior	Very low	Very high	Medium to high	Medium to high
Chemical	Reducing	Reducing	Reducing	Reducing
Heat resistance	High	Low	High	High
Mining experience	High	Low	High	Low
Available geology*	Wide	Wide	Medium	Wide
Geologic stability	High	High	High	High
Engineered barriers	Minimal	Minimal	Needed	Minimal

Favorable property
 Average
 Unfavorable property

* See accompanying figures.

Technical Factors in Site Suitability

- **We anticipate that the U.S. will develop new radioactive waste management policy.**
 - Many of the policy issues debated in the 1970s and early 1980s will be revisited.
- **Evaluating the suitability of a particular disposal concept (to eventually include siting) will require a regulatory framework.**
- **The U.S. has multiple, technically promising geologic disposal options (example technical screening data)**

Example Technical Screening Data: Generalized Glacial Limits

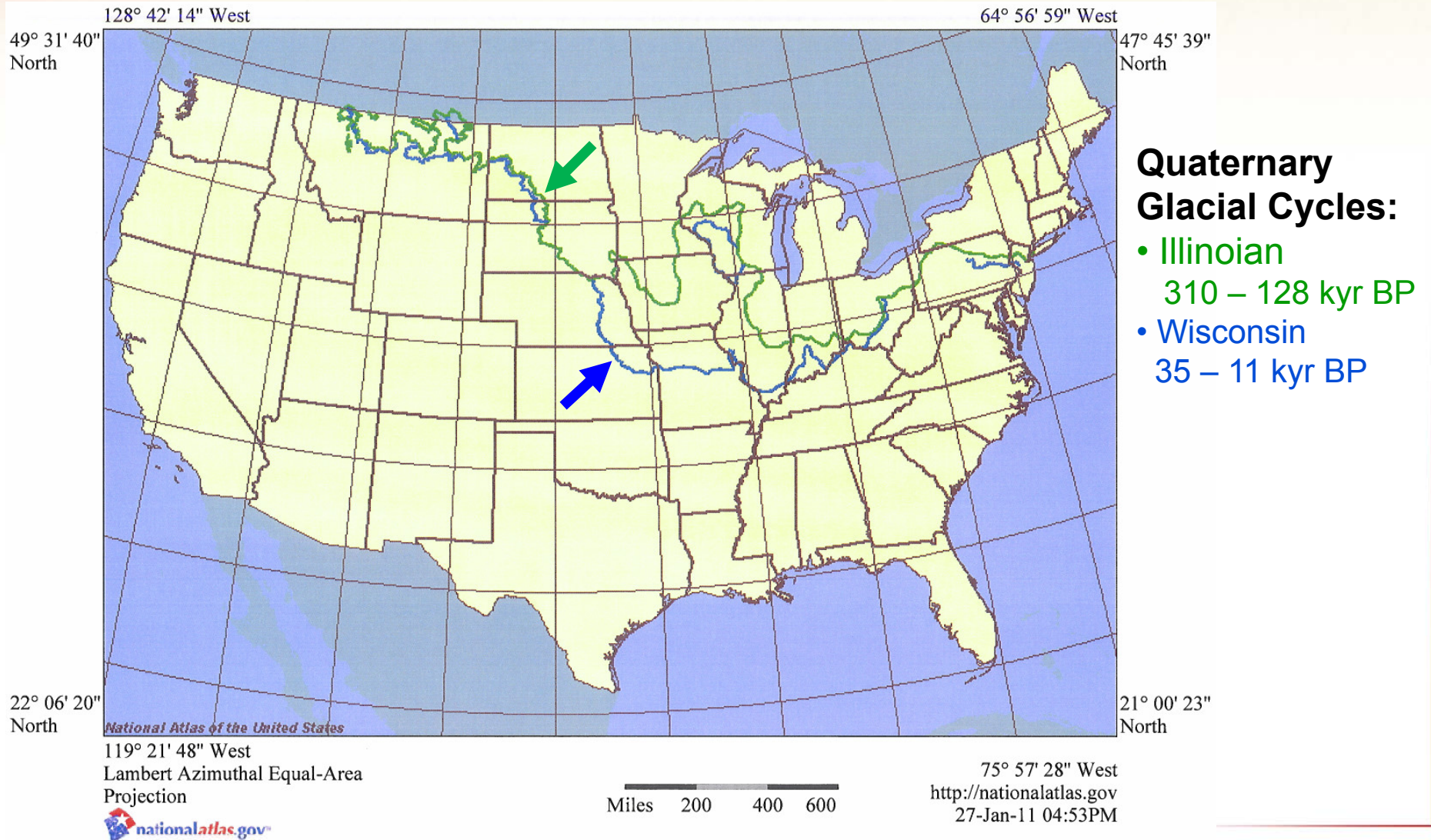

Example Technical Screening Data: + Volcanoes (<10 kyr)

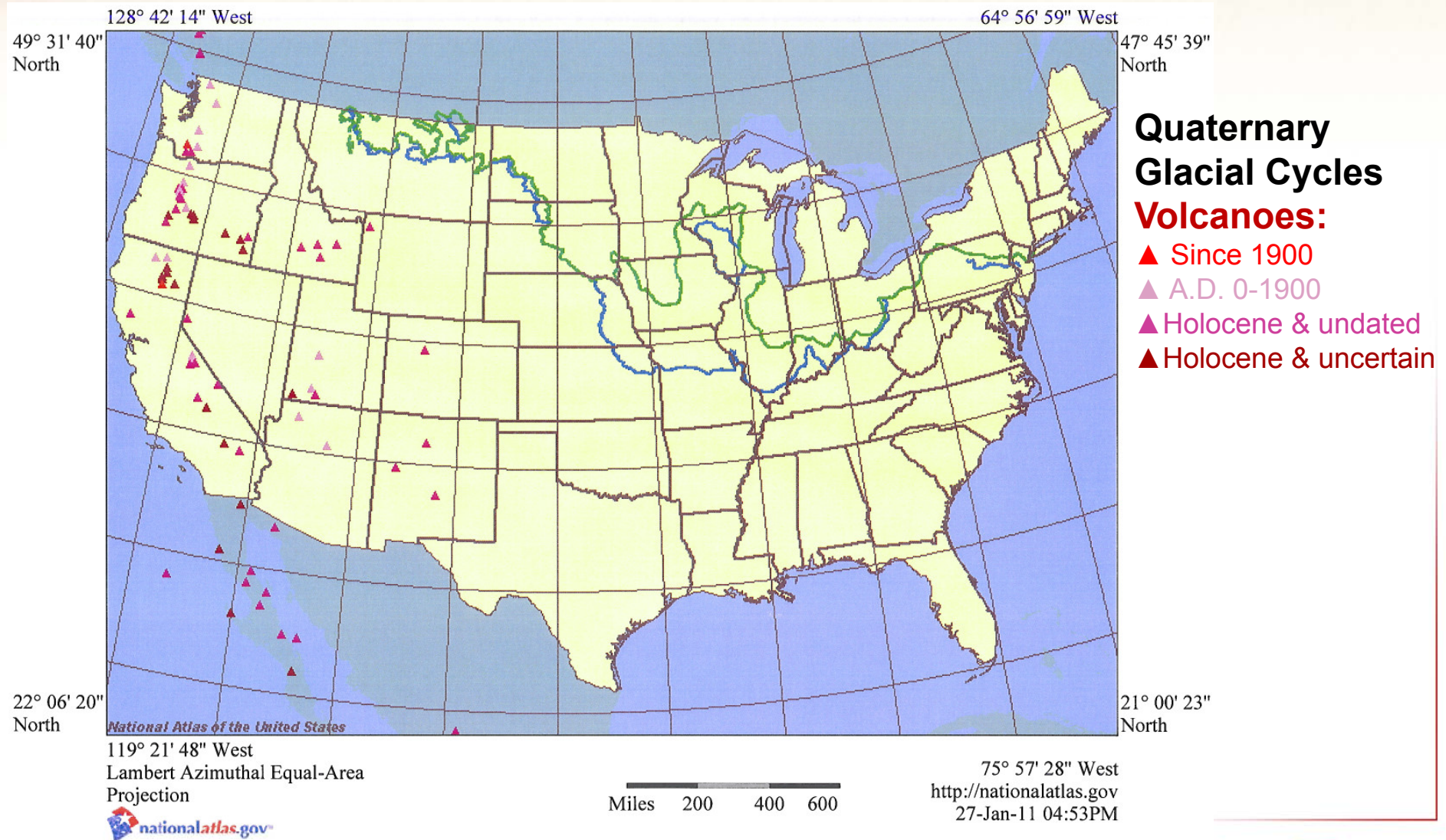

Example Technical Screening Data: + Quaternary Faults/Fault Zones

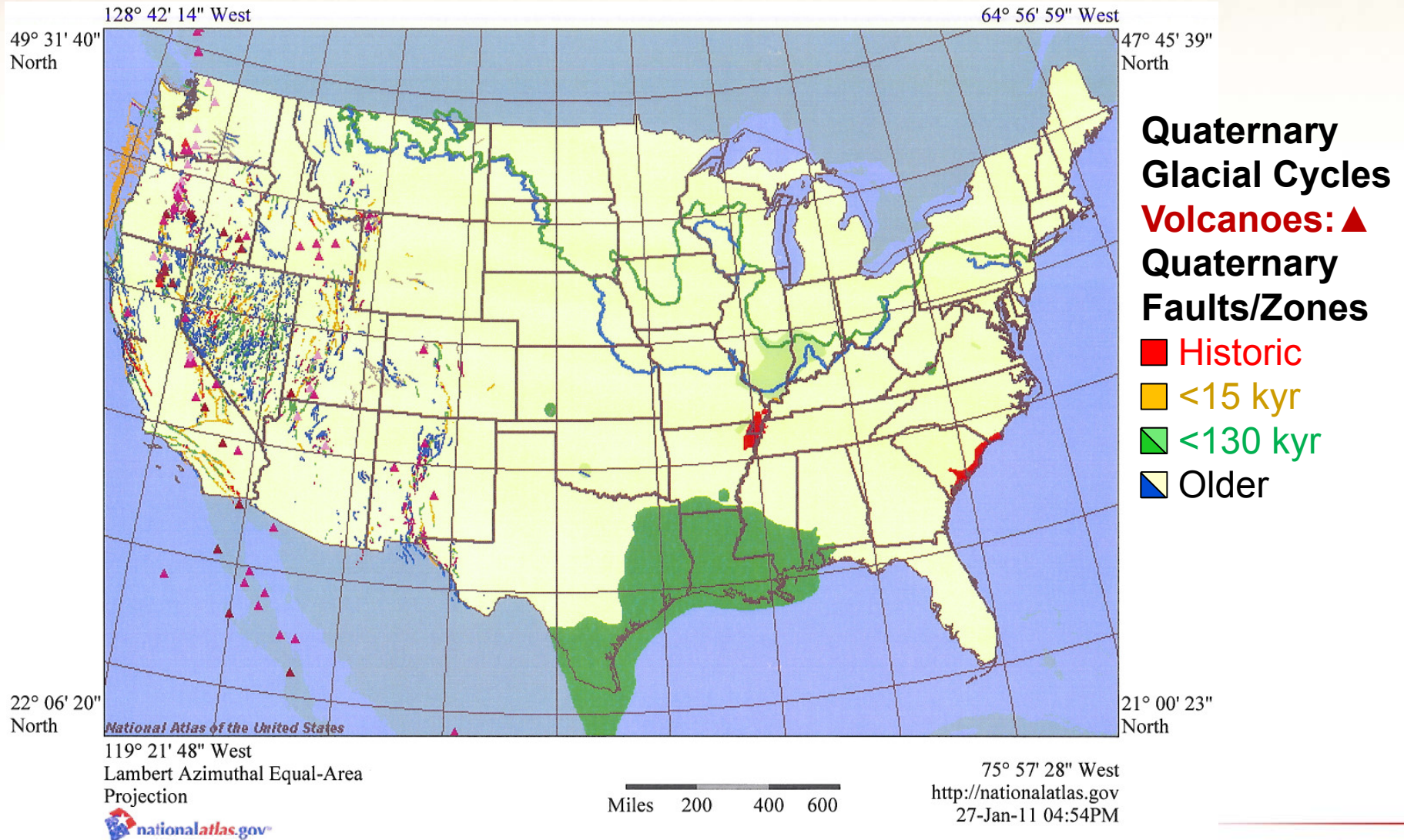

Example Technical Screening Data: + Earthquakes 1568-2009

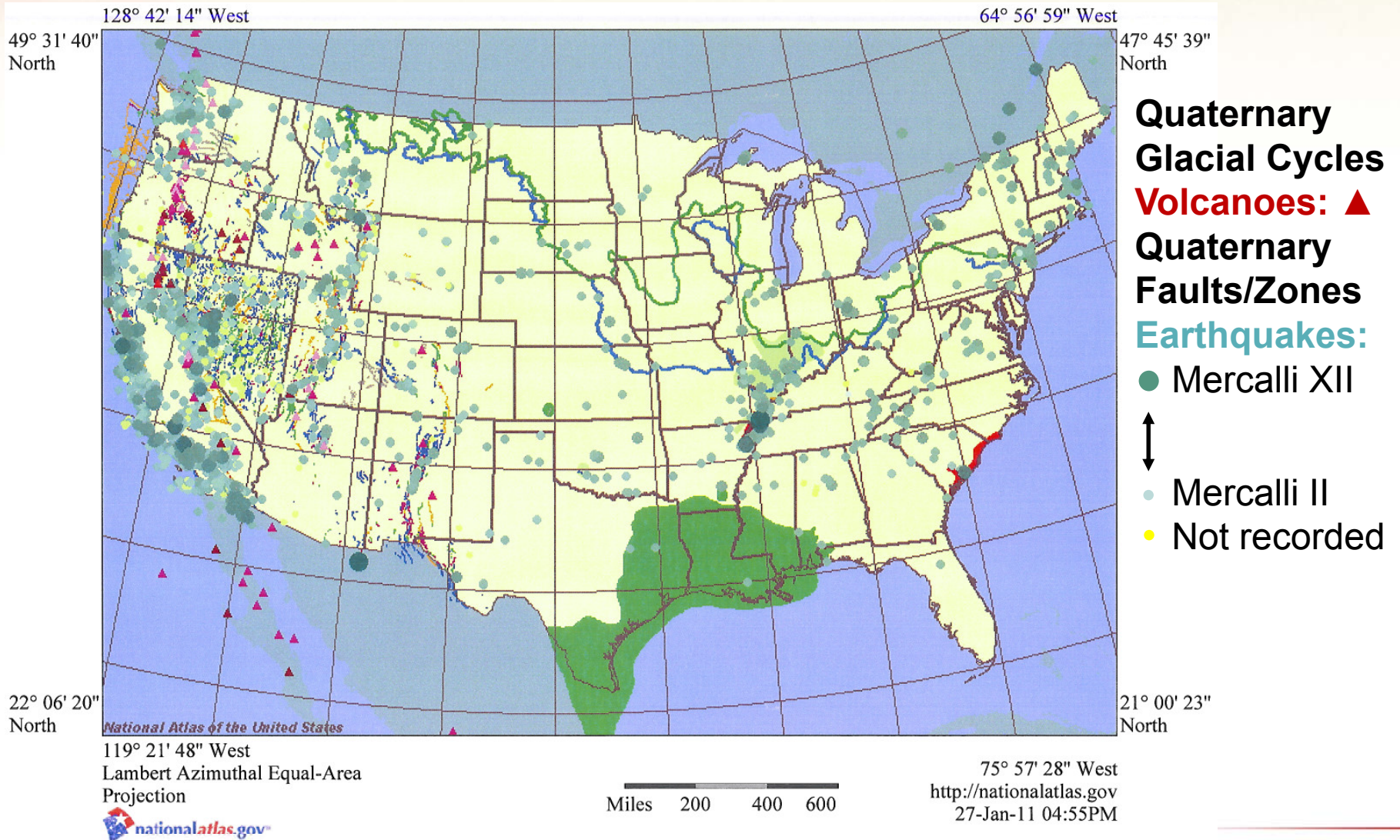

Example Technical Screening Data: + Seismic Hazard

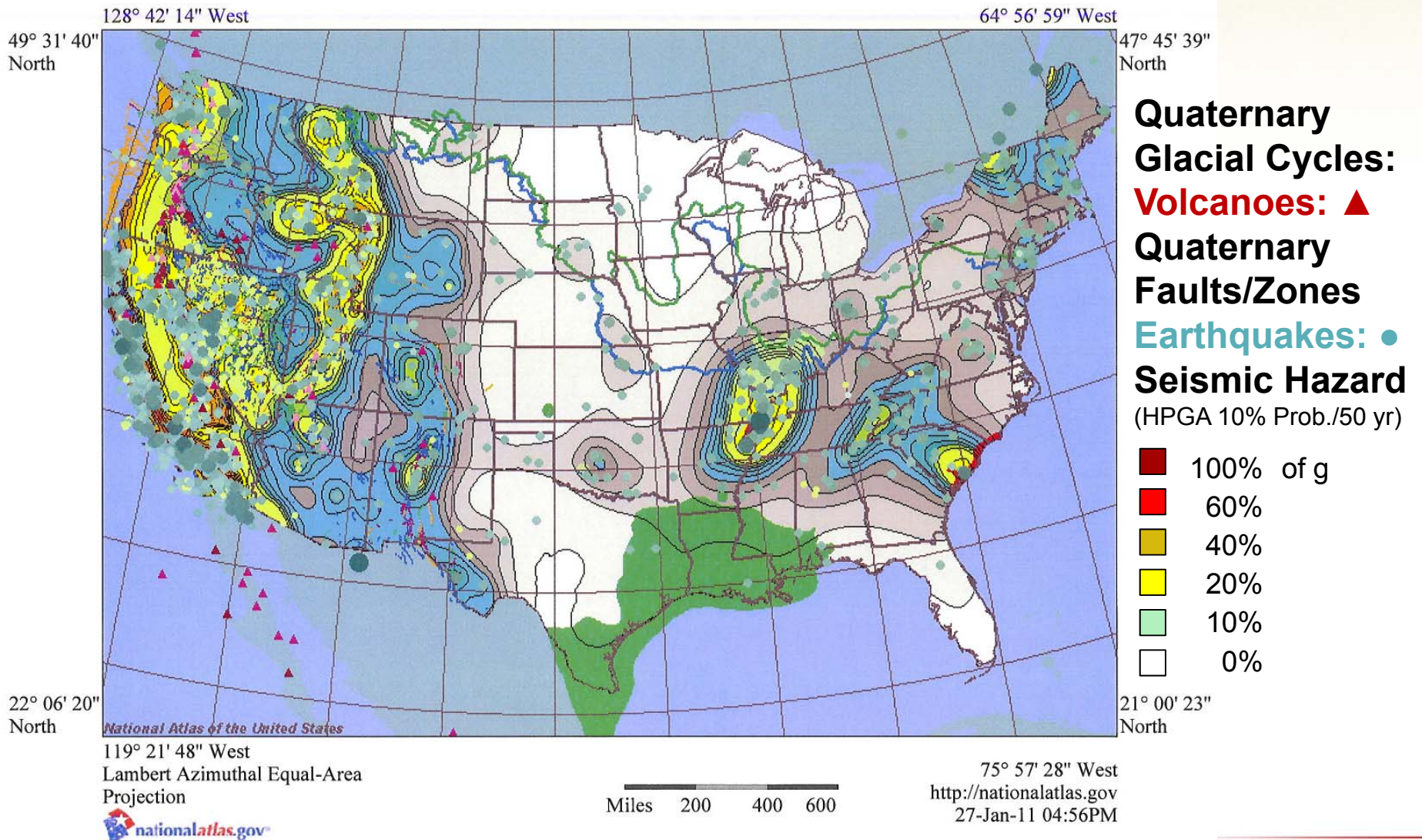

Example Technical Screening Data: Base Map + Surficial Granite Overlay

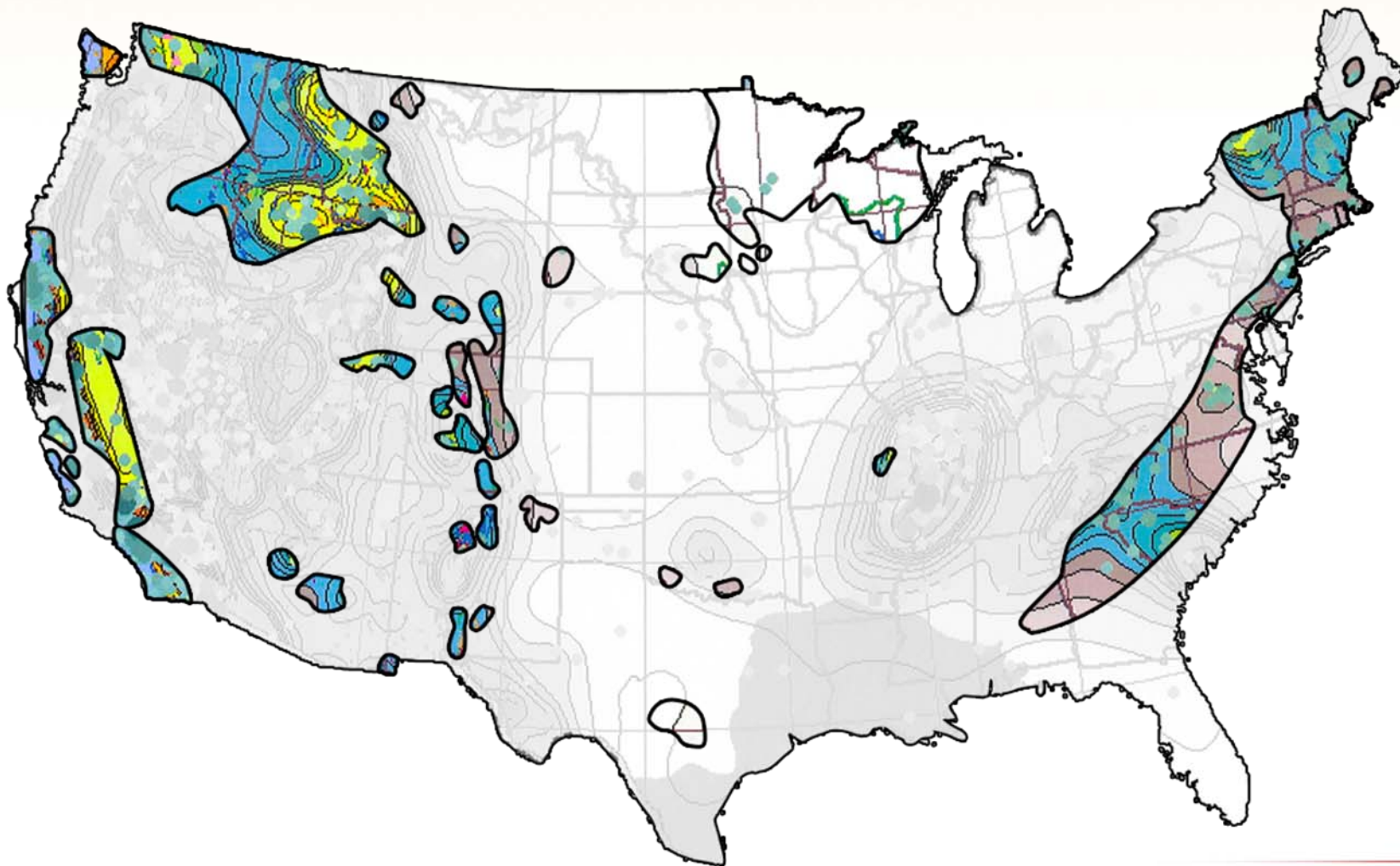

Example Technical Screening Data: Base Map + Shale Overlay

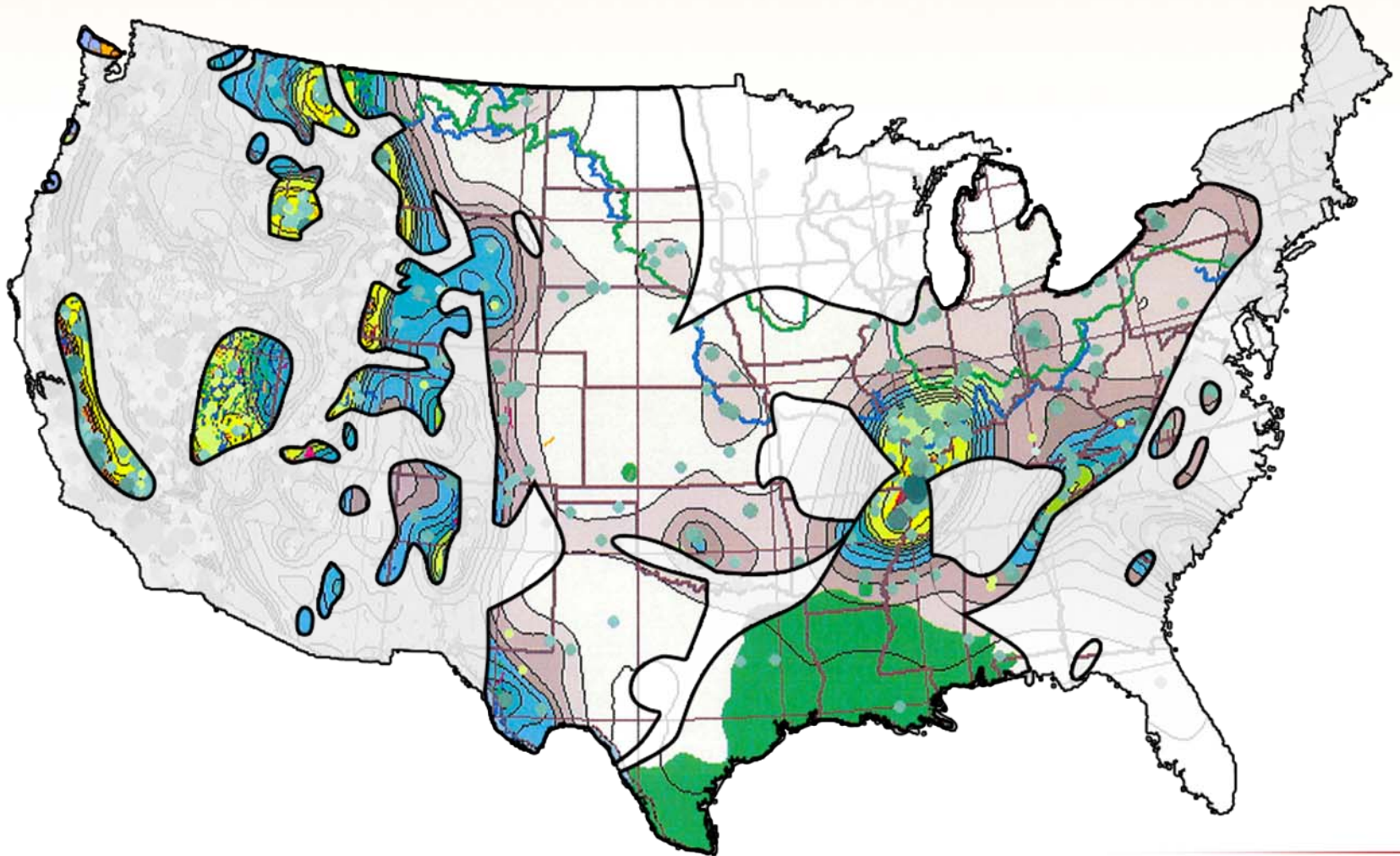

Example Technical Screening Data: Base Map + Salt Overlay

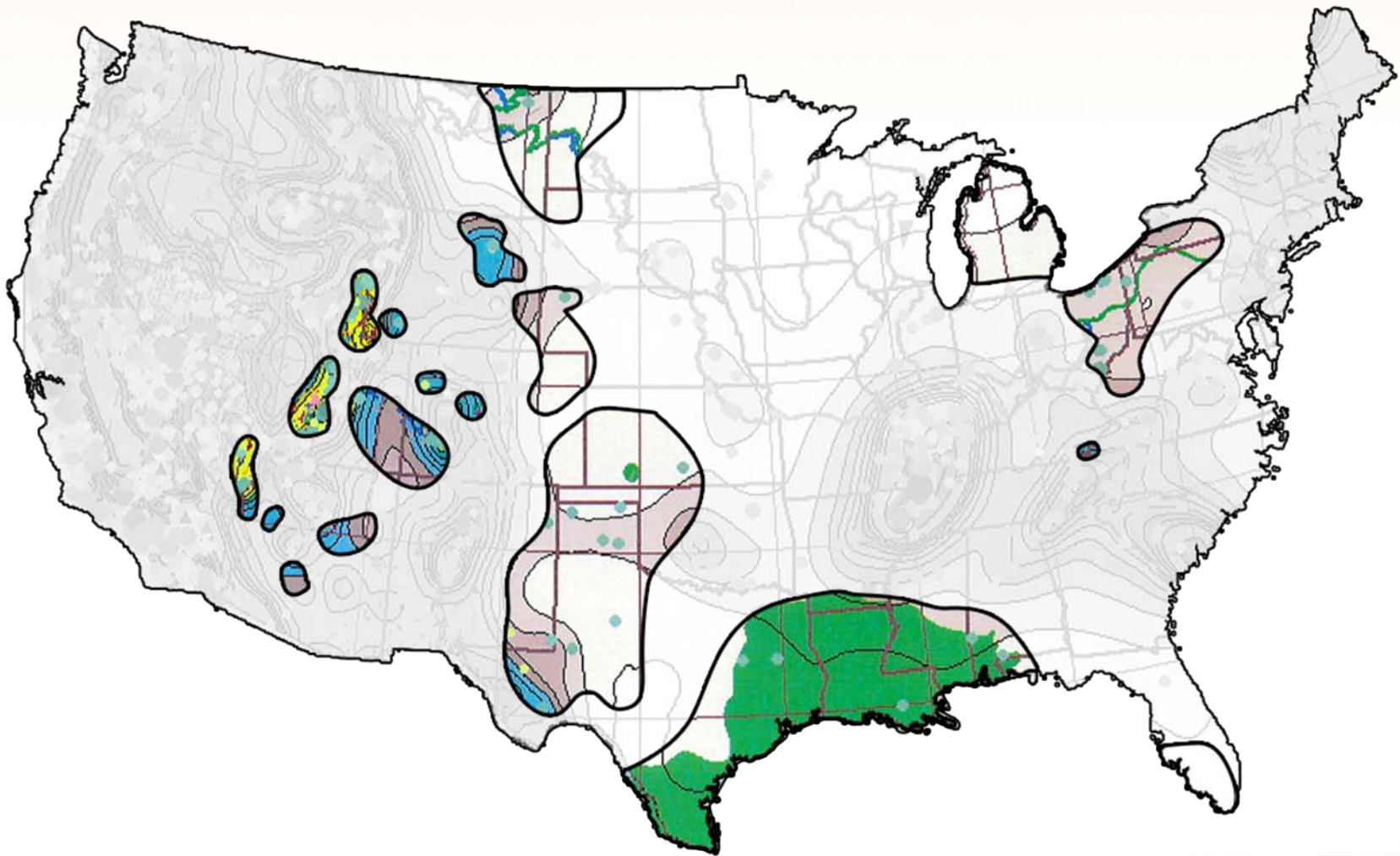

Site Screening Methodology

• Interpretation of Geographic Overlays

- Use of geographic data should seek to represent all important aspects of disposal system performance.
 - Geologic diversity couples to appropriate disposal concepts
 - Natural and engineered barriers
- Data resolution should correspond to the scale of features that affect system performance.
- Data sources, and uncertainty should be understood.

• Repository Siting Experience

- U.S. first and second repository programs (< 1988)
- Sweden, France, others
- Phasing, transparent decision process, review, and consultation are critical

Concluding Remarks

- **The U.S. has multiple, technically promising geologic disposal options.**
- **Technical site screening and suitability evaluations depend on the disposal concept.**
- **New radioactive waste management policy will determine how and when siting and suitability evaluations are performed.**
- **Suitability evaluations for a particular disposal concept (to include siting) will require a legal/regulatory framework.**



BACKUP SLIDES

Surface Geology

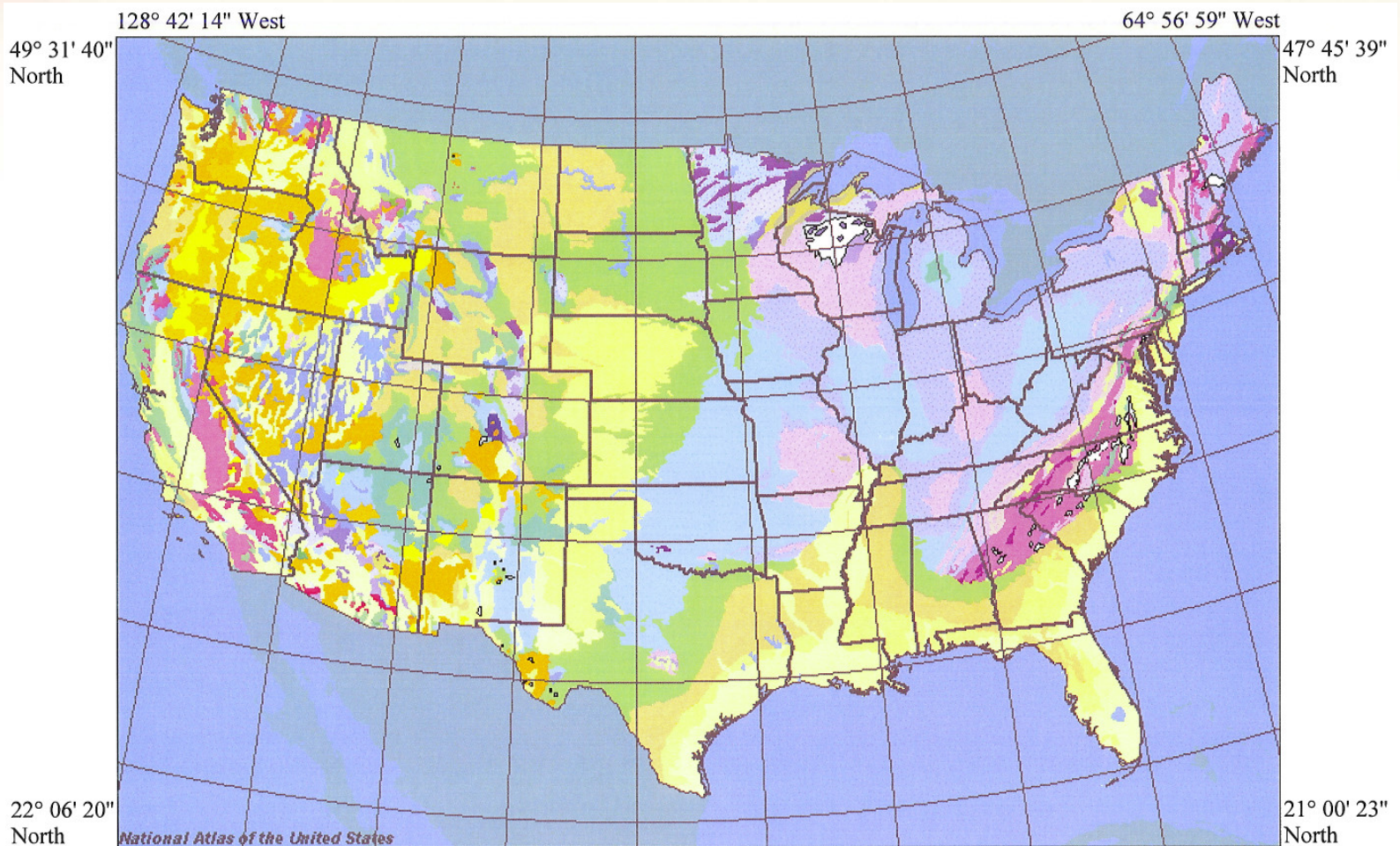

Lambert Azimuthal Equal-Area
Projection

 nationalatlas.gov

Miles 200 400 600

<http://nationalatlas.gov>
27-Jan-11 04:10PM

Waste Handling/Storage Demonstration in Granite at the Nevada Test Site (NNSS)



Spent Fuel Test – Climax (1978-1986)
Waste Canister Drift

Disposal Configuration for Transuranic Waste at the WIPP



Simulating HLW at WIPP



Example Technical Screening Data: Fresh Groundwater Withdrawal (2005)

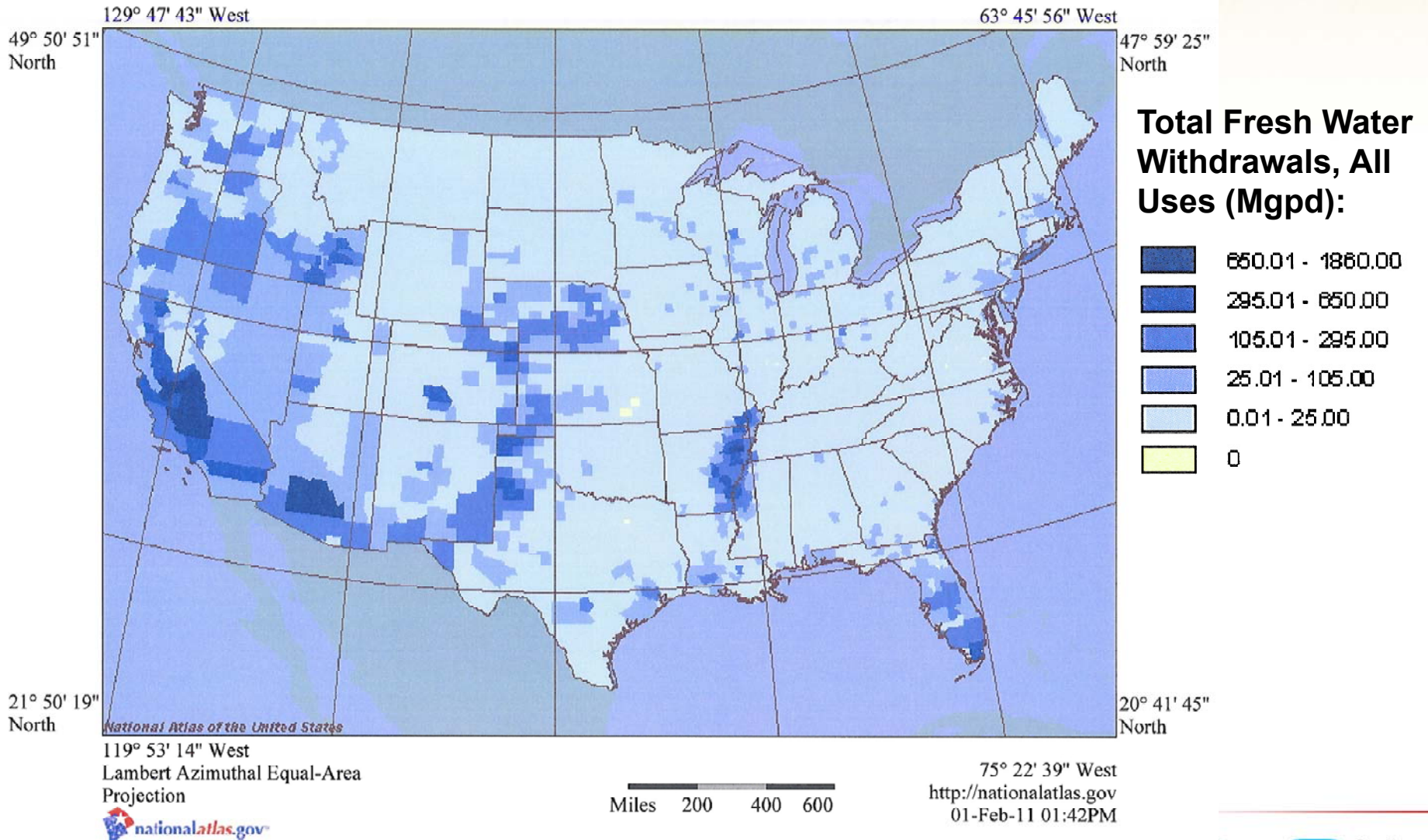

Example Technical Screening Data: Average Annual Precip., Streams & Waterbodies

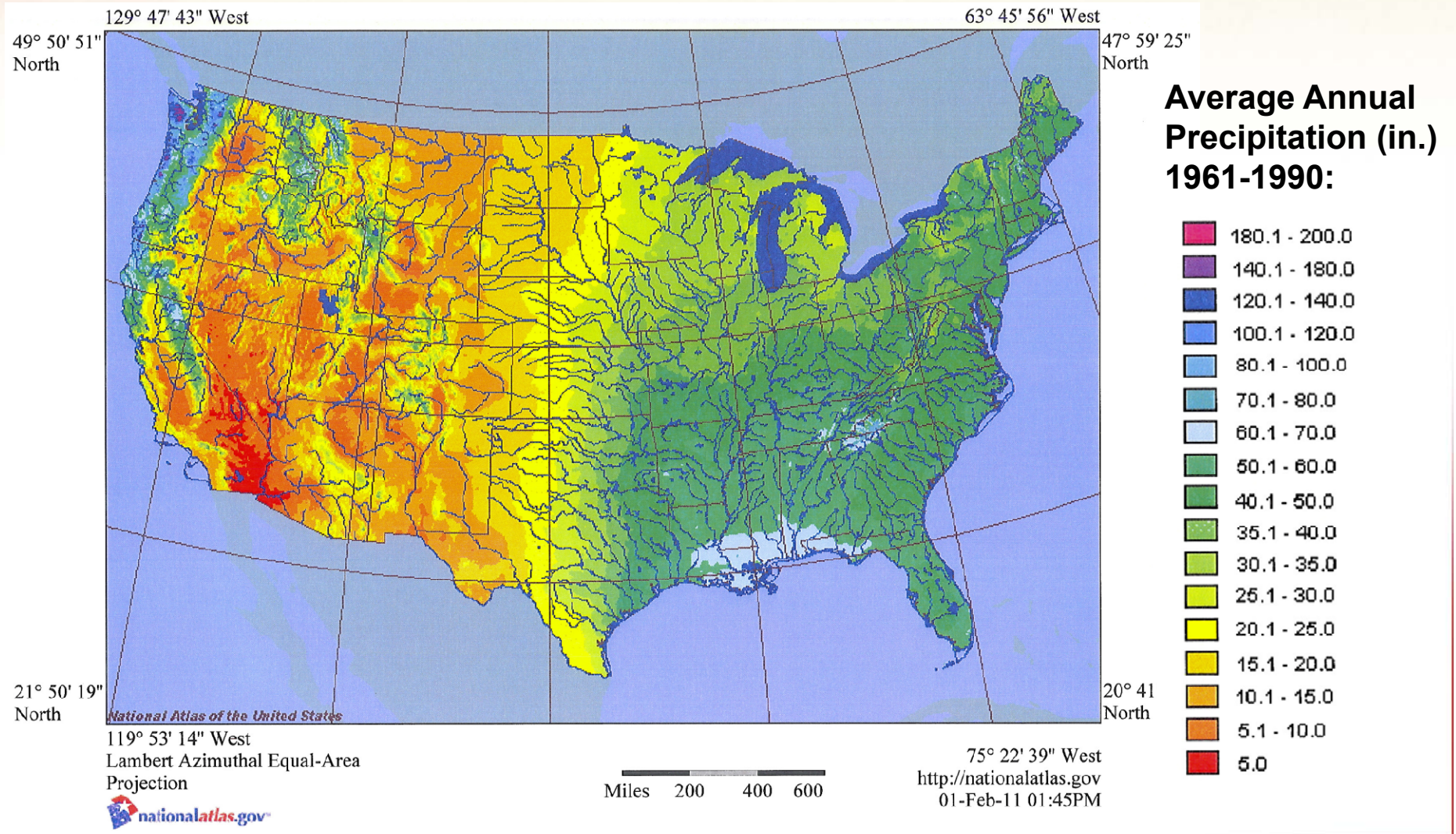

References

- Brady, P.V. et al. 2009. *Deep Borehole Disposal of High-Level Radioactive Waste*. Sandia National Laboratories, Albuquerque, NM. SAND2009-4401.
- Bush, J.B. 1976. *Economic and Technical Feasibility Study of Compressed Air Storage*. ERDA 76-76 Report prepared by General Electric Company. Schenectady, N.Y.
- Clayton, D.J. & C.W. Gable 2009. *3-D Thermal Analyses of High-Level Waste Emplaced in a Generic Salt Repository*. U.S. Dept. of Energy, Office of Nuclear Fuel Recycling. AFCI-WAST-PMO-MI-DV-2009-000002.
- Hansen, F.D. et al. 2010. *Shale Disposal of U.S. High-Level Radioactive Waste*. Sandia National Laboratories, Albuquerque, NM. SAND2010-2843.
- Hansen, F.D. et al. 2011. "Geologic Disposal Options in the USA." Waste Management 2011, February 27-March 3, 2011. WM Symposia, Phoenix, Arizona.
- Johnson, K.S. and S. Gonzales, 1978. *Salt deposits in the United States and regional geologic characteristics important for storage of radioactive waste*. Prepared for the Office of Waste Isolation, Union Carbide Corporation, Nuclear Division. Y/OWI/SUB—7414/1.
- Pastina, B. and P. Hella 2010. *Models and Data Report 2010*. POSIVA OY, Oikiluoto, FIN-27160 Eurajoki, Finland. POSIVA 2010-01.
- U.S. Geological Survey, <http://www.nationalatlas.gov>
- Washington Savannah River Co. et al. 2008. *A Generic Salt Repository for Disposal of Waste from a Spent Nuclear Fuel Recycling Facility*. PREDECISIONAL DRAFT Rev 1. U.S. Dept. of Energy, Global Nuclear Energy Partnership. GNEP-WAST-MTSD-MI-RT-2008-000245.